

As-18

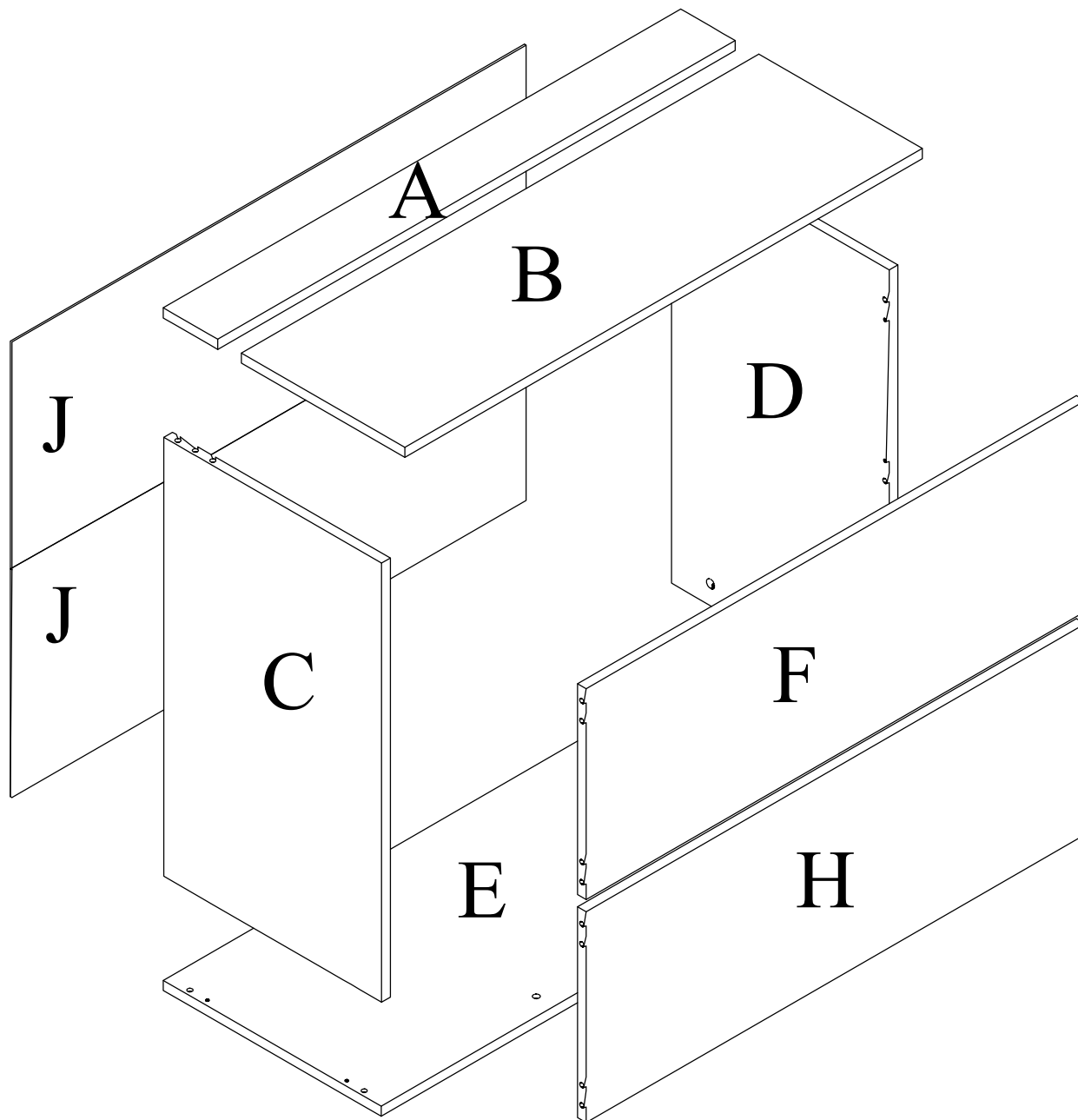

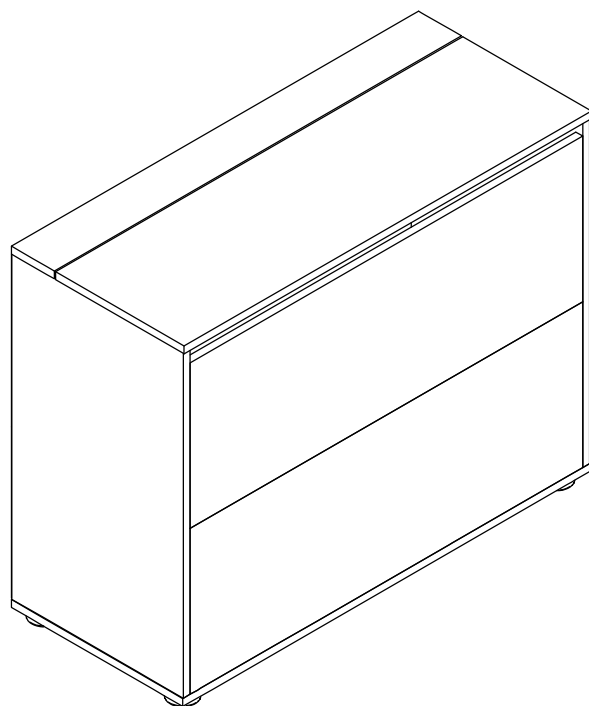

1.)

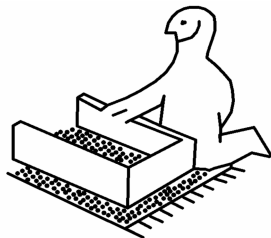
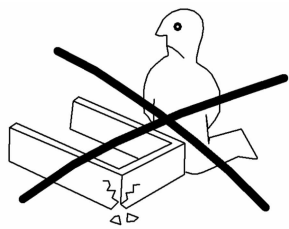
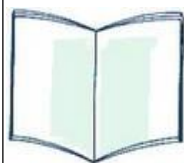
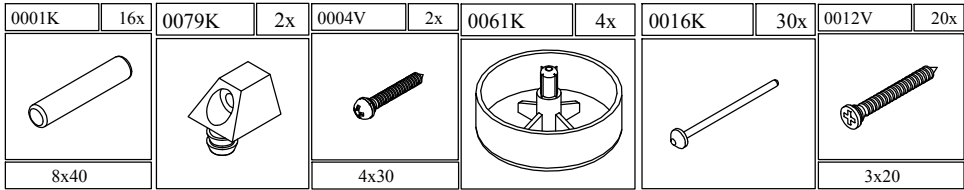
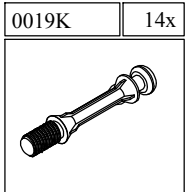
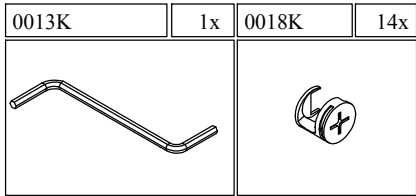
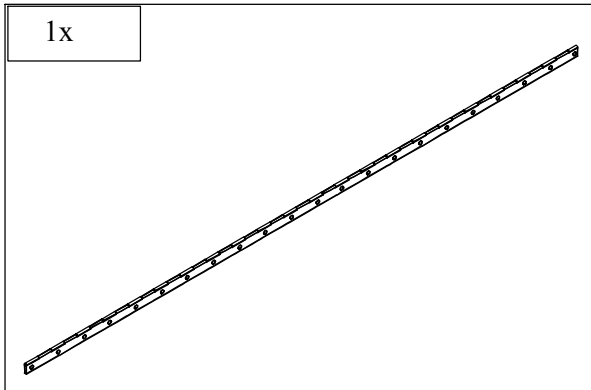
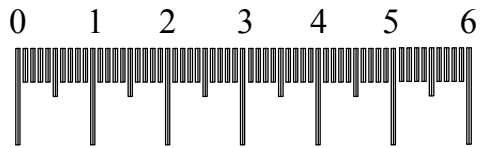
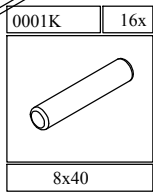
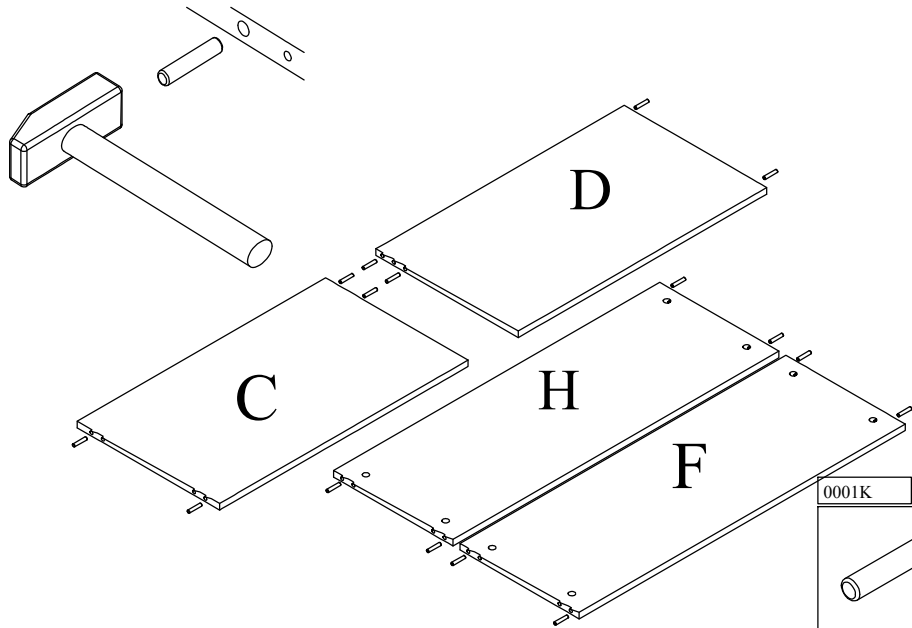

2.)

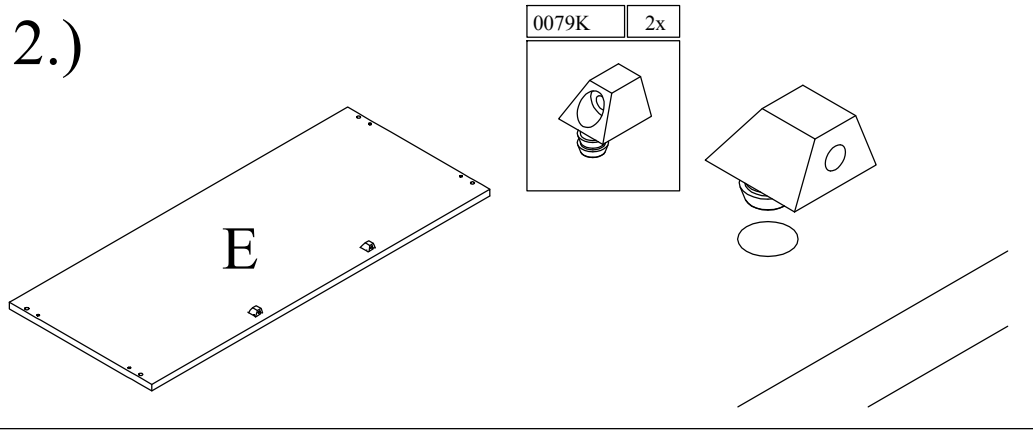

3.)

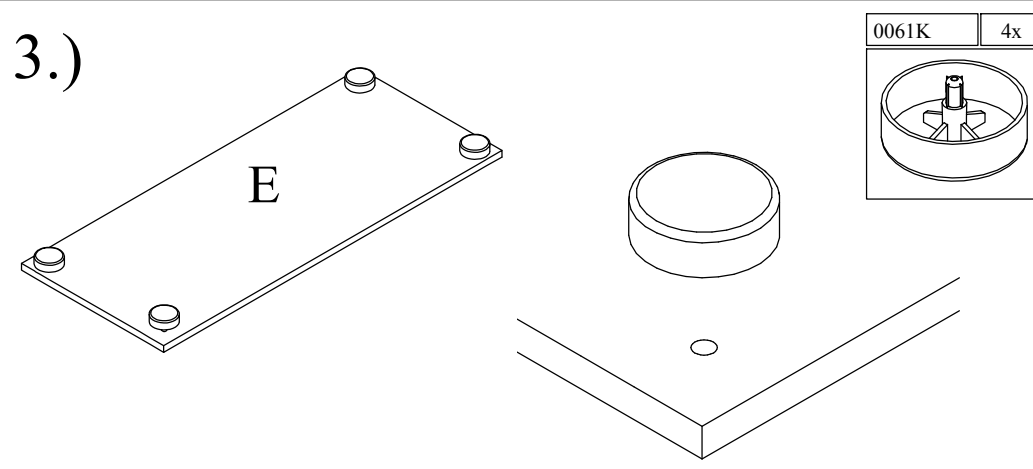

4.)

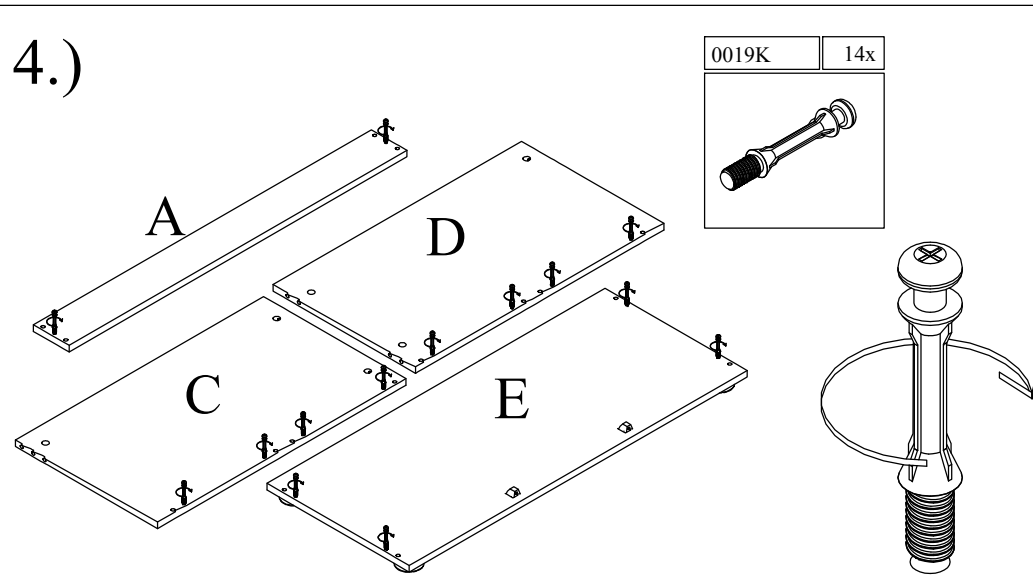

5.)

0018K 12x

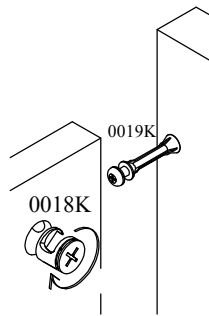
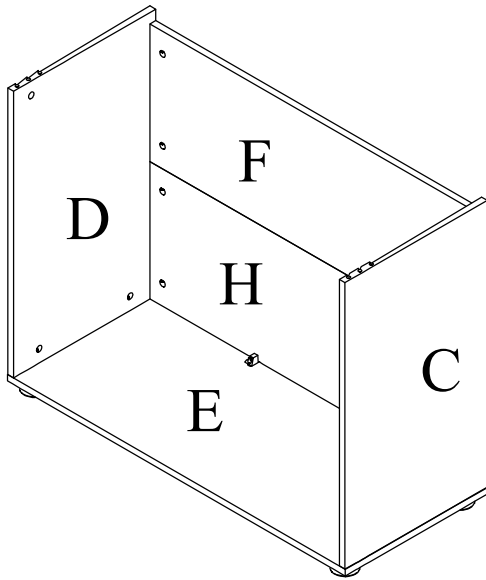
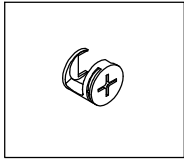

7.)

0004V 2x
4x30

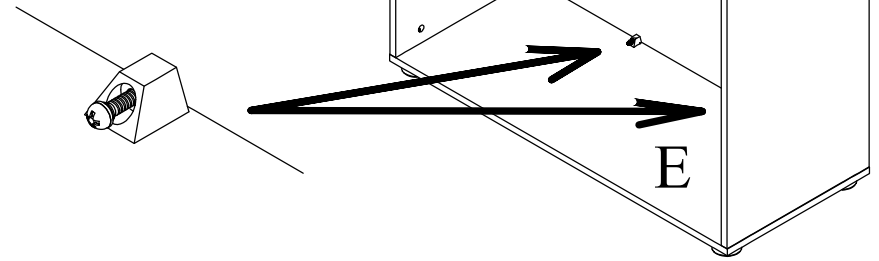
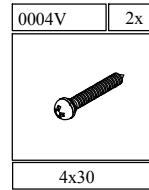

6.)

0018K 2x

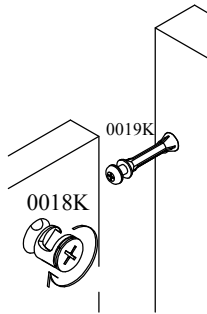
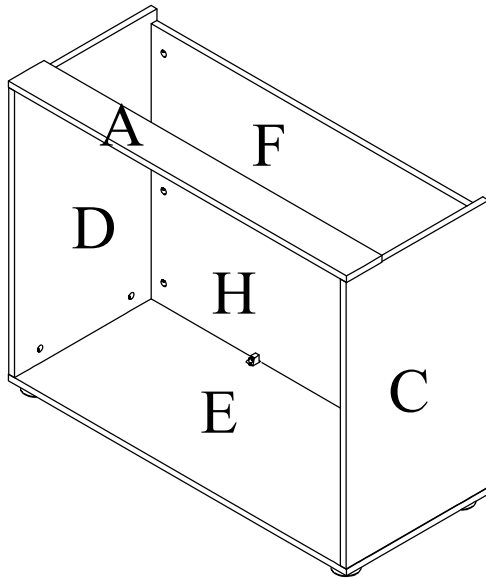
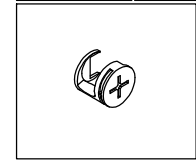

8.)

0016K 30x

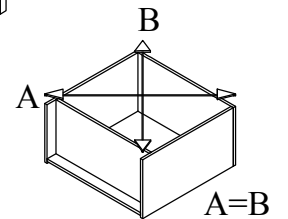
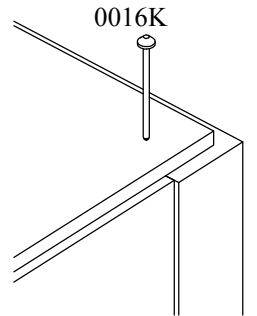
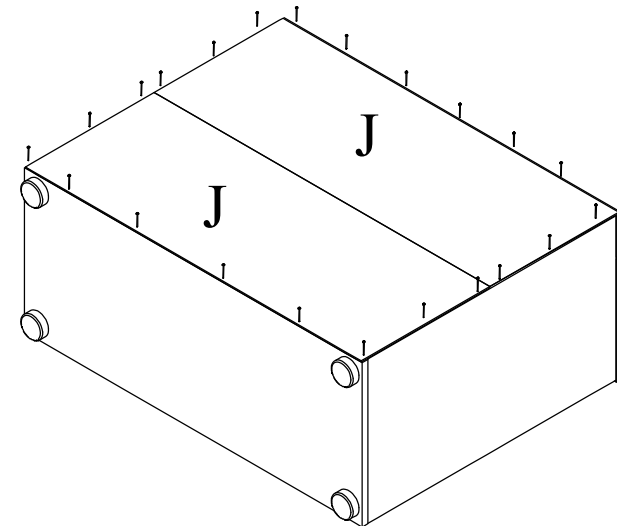
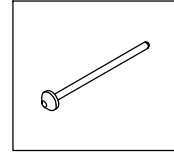

9.)

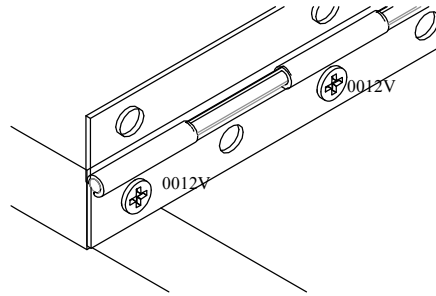
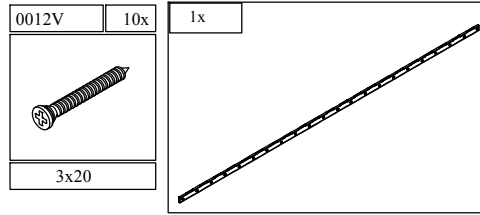
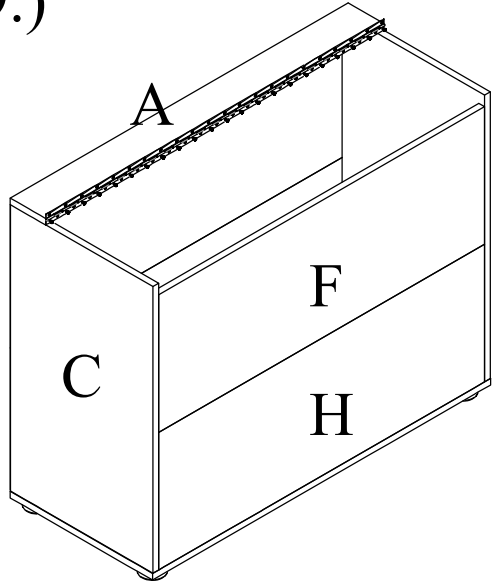

10.)

